



**rabalux<sup>®</sup>**

**Outdoor  
New Products  
2024**

# OVERVIEW



DOMME  
77069  
4



DOMME  
77070  
4



ANDELLE  
77095  
5



ANDELLE  
77096  
5



RENNES  
77094  
5



GIMONE  
77097  
6



GIMONE  
77098  
6



ZARAGOZA  
77092  
7



ZARAGOZA  
77093  
7



MATARO  
77073  
8



MATARO  
77074  
8



MATARO  
77075  
8



MATARO  
77076  
8



LUBLIN  
77099  
9



LUBLIN  
77100  
9



TEMSE  
77065  
10



TEMSE  
77066  
10



TILBURG  
77049  
12



TILBURG  
77050  
12



OGNON  
77051  
12



HULST  
77041  
14



GENDT  
77061  
14



INDRE  
77035  
15



INDRE  
77036  
15



ODIEL  
77057  
16



ODIEL  
77058  
16



ODIEL  
77059  
17



ODIEL  
77060  
17



TELDE  
77101  
18



TELDE  
77102  
18



MEDNA  
77103  
19



MEDNA  
77104  
19



KALISZ  
77031  
20



KALISZ  
77032  
20



KALISZ  
77033  
20



CERNON  
77054  
22



# OVERVIEW



CERNON  
77055  
22



CERNON  
77056  
22



HAREN  
77083  
23



HAREN  
77084  
23



LOANDA  
77080  
24



LOANDA  
77081  
24



LOANDA  
77082  
24



ZERNEST  
77085  
25



ZERNEST  
77086  
25



ZERNEST  
77087  
25



LASSET  
77078  
26



LASSET  
77079  
26



GELEEN  
77044  
27



GELEEN  
77045  
27



ANGERS  
77037  
28



ANGERS  
77038  
28



ANGERS  
77039  
28



SENICA  
77064  
29



TRENTO  
77105  
29



FLAXTON  
77040  
30



FLAXTON  
77090  
30



LESZNO  
77091  
31



NANTES  
77088  
31



EMMEN  
77034  
32



LUTTO  
77030  
32



RUPIT  
77047  
33



TITU  
77048  
33



SLUIS  
77046  
33



KONIN  
77089  
34



ASSEN  
77062  
35

# DOMME



77069

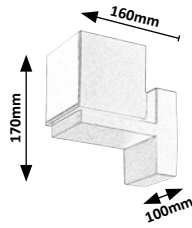

77070

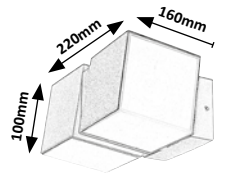

**77069** (M) (P)

LED / 6W  
(380lm, 800lm;  
3000K) incl. • IP54  
black/white



5 996595 770693

**77070** (M) (P)

LED / 12W  
(670lm, 1400lm;  
3000K) incl. • IP54  
black/white



5 996595 770709



# ANDELLE



77095

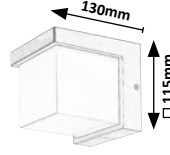

77096

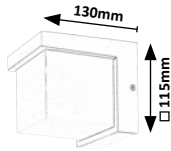

# RENNES



77094

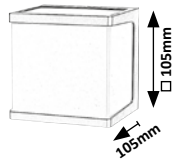

**77095**

**(P)**

LED / 10W  
 (500lm, 1000lm;  
 3000K) incl. • IP54  
 black/white



5 996595 770952

**77096**

**(P)**

LED / 10W  
 (570lm, 1000lm;  
 3000K) incl. • IP54  
 white



5 996595 770969

**77094**

**(P)**

LED / 10W  
 (580lm, 1000lm;  
 4000K) incl. • IP54  
 anthracite grey/white



5 996595 770945

# GIMONE



77097

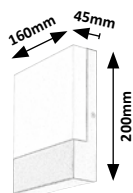

77098

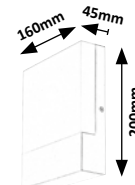

**77097**



LED / 10W  
(570lm, 1000lm;  
4000K) incl. • IP44  
black/white



5 996595 770976

**77098**



LED / 10W  
(660lm, 1000lm;  
4000K) incl. • IP44  
white



5 996595 770983



# ZARAGOZA



77092

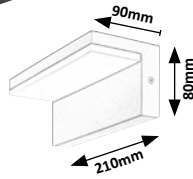

77093

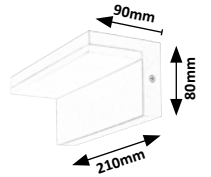

**77092**



LED / 10W  
(560lm, 1000lm;  
4000K) incl. • IP54  
black/white



5 996595 770921

**77093**



LED / 10W  
(780lm, 1000lm;  
4000K) incl. • IP54  
white



5 996595 770938

# MATARO



77073

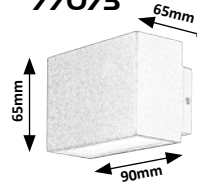

77074

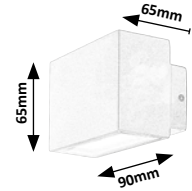

77075

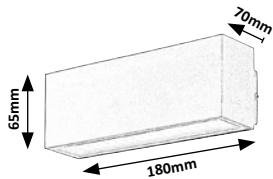

77076

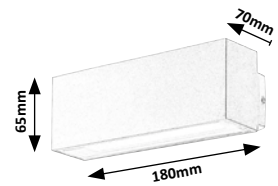

**77073** (M) (G)

LED / 7W  
 (430lm, 800lm;  
 4000K) incl. • IP54  
 black/white



5 996595 770730

**77074** (M) (G)

LED / 7W  
 (580lm, 800lm;  
 4000K) incl. • IP54  
 white



5 996595 770747

**77075** (M) (G)

LED / 10W  
 (720lm, 1200lm;  
 4000K) incl. • IP54  
 black/white



5 996595 770754

**77076** (M) (G)

LED / 10W  
 (970lm, 1200lm;  
 4000K) incl. • IP54  
 white



5 996595 770761



# LUBLIN



77099

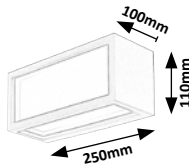

77100

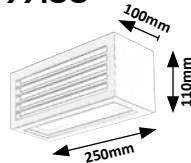

**77099** (M) (P)

LED / 10W  
 (480lm, 1000lm; 4000K) incl.  
 IP54 • 20053  
 black/white



5 996595 770990

**77100** (M) (P)

LED / 10W  
 (480lm, 1000lm; 4000K) incl.  
 IP54 • 20053  
 black/white



5 996595 771003



# TEMSE



**77065**

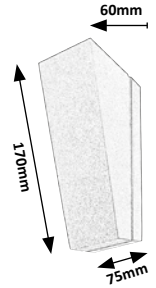

**77066**

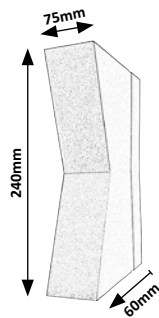

**77065** (M) (P)

LED / 3W  
( $\Phi$ 140lm,  $\Phi$ 280lm;  
4000K) incl. • IP65  
anthracite grey/transparent



5 996595 770655

**77066** (M) (P)

LED / 6W  
( $\Phi$ 290lm,  $\Phi$ 560lm;  
4000K) incl. • IP65  
anthracite grey/transparent



5 996595 770662



# TILBURG

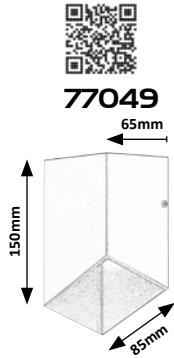

77049



77050

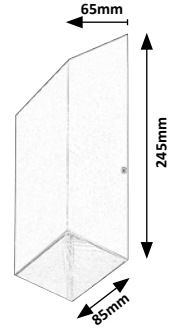

# OGNON



77051

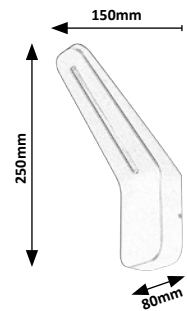

77049 (M) (G)

LED / 5W  
 (3160lm, 3550lm;  
 3000K) incl. • IP54  
 anthracite grey/transparent



5 996595 770495

77050 (M) (G)

LED / 10W  
 (3350lm, 1150lm;  
 3000K) incl. • IP54  
 anthracite grey/transparent



5 996595 770501

77051 (M) (G)

LED / 8W  
 (3500lm, 3950lm;  
 3000K) incl. • IP54  
 anthracite grey/white



5 996595 770518



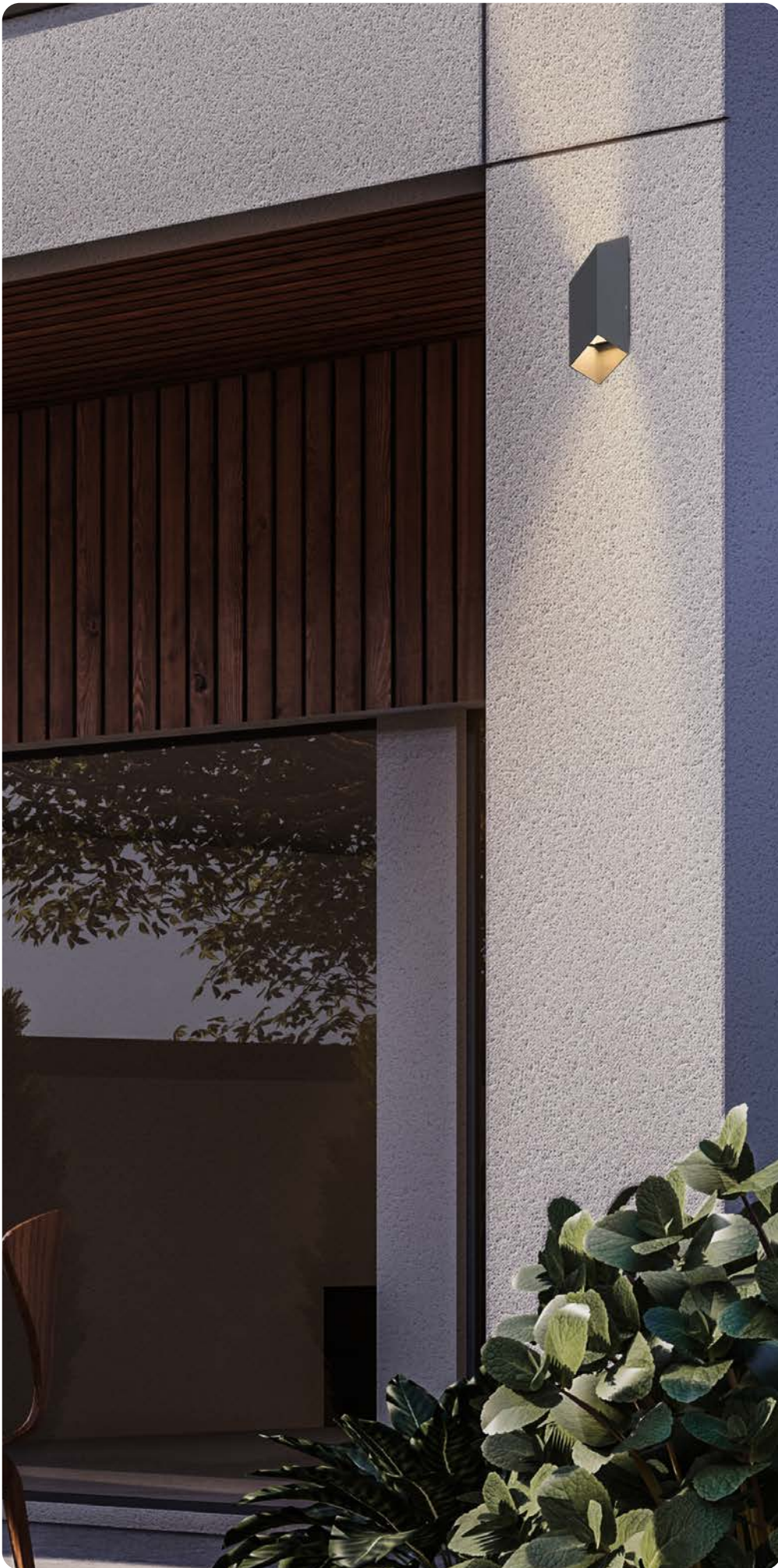

# HULST



7704I

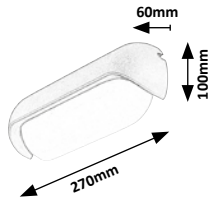

# GENDT



7706I

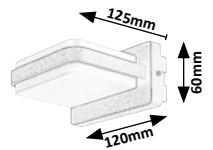

## 7704I (M) (P)

LED / 13W  
(850lm, 1500lm;  
3000K) incl. • IP65  
anthracite grey/white



5 996595 770419

## 7706I (M) (P)

LED / 12W  
(800lm, 1300lm;  
3000K) incl. • IP44  
black/white



5 996595 770617





# INDRE



77035

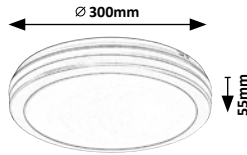

77036

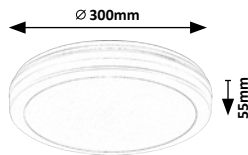

**77035**



LED / 28W  
 (2450lm, 3450lm;  
 3000K-4000K-6500K) incl. • IP54  
 black/white



5 996595 770358

**77036**



LED / 28W  
 (2600lm, 3450lm;  
 3000K-4000K-6500K) incl. • IP54  
 white



5 996595 770365



# ODIEL



77057

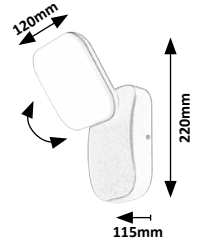

77058

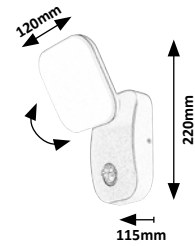

**77057** (M) (P)

LED / 12W  
(800lm, 1400lm;  
3000K) incl. • IP44  
black/white



5 996595 770570

**77058** (M) (P)

LED / 12W  
(850lm, 1400lm; 3000K) incl.  
IP44 • 8±2m, 110°  
black/white



5 996595 770587



# ODIEL



77059

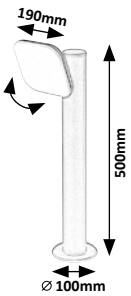

77060

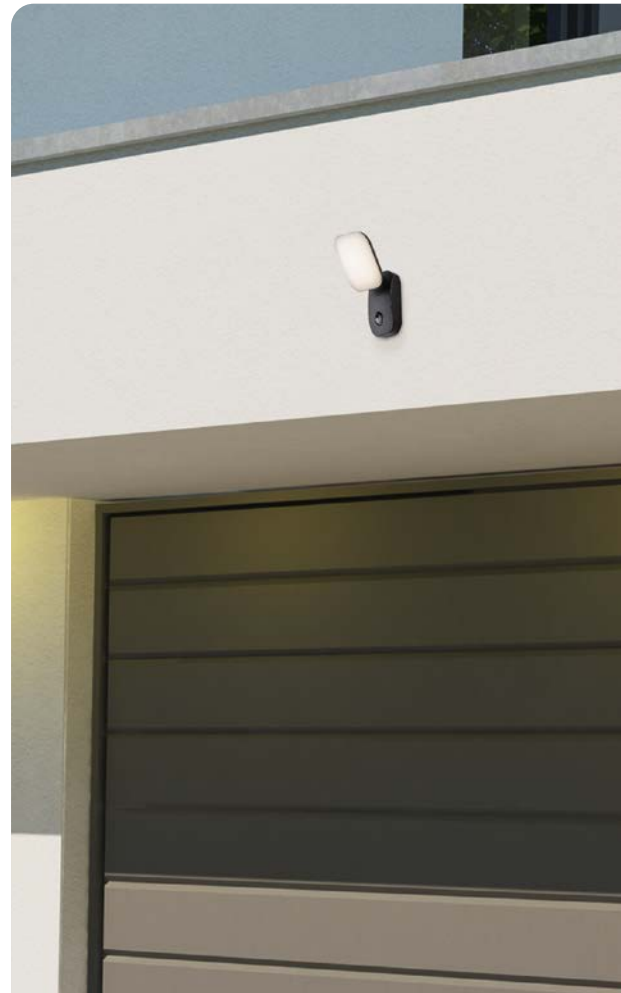
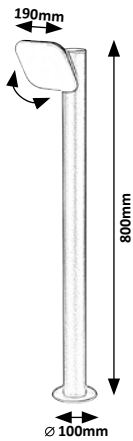

**77059** (M) (P)

LED / 12W  
 (750lm, 1400lm;  
 3000K) incl. • IP44  
 black/white



5 996595 770594

**77060** (M) (P)

LED / 12W  
 (720lm, 1400lm;  
 3000K) incl. • IP44  
 black/white



5 996595 770600

# TELDE



77101

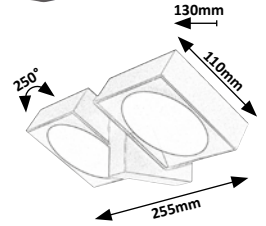

77102

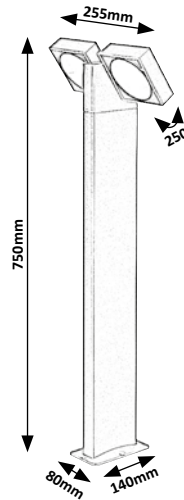

**77101** **M G**

LED / 14W  
(900lm, 1620lm;  
3000K) incl. • IP54  
anthracite grey/transparent



5 996595 771010

**77102** **M G**

LED / 14W  
(900lm, 1620lm;  
3000K) incl. • IP54  
anthracite grey/transparent



5 996595 771027

# MEDNA



77103

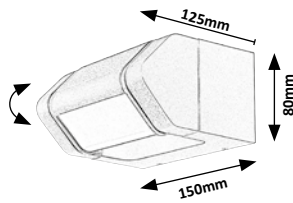

77104

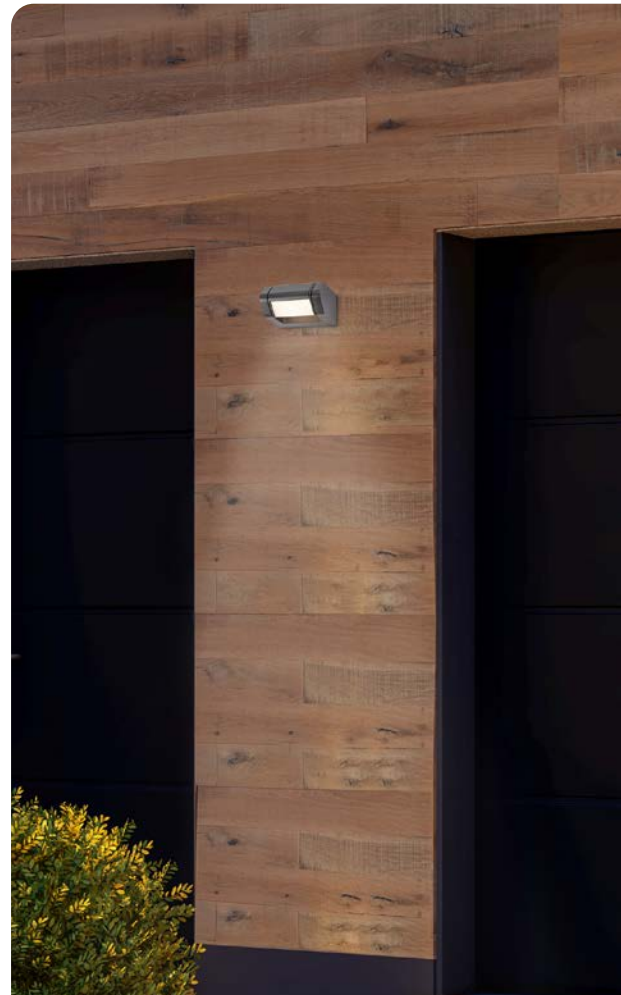
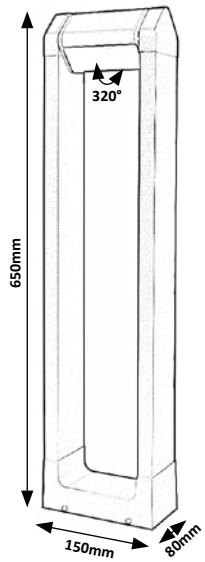

**77103** (M) (P)

LED / 8W  
 (530lm, 930lm;  
 3000K) incl. • IP54  
 anthracite grey/white



5 996595 771034

**77104** (M) (P)

LED / 8W  
 (530lm, 930lm;  
 3000K) incl. • IP54  
 anthracite grey/white



5 996595 771041

# KALISZ



77031

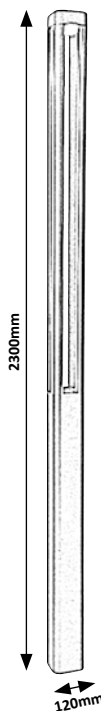

A talp bebetonozása szükséges.  
The base concreting is required.  
Das Betonieren des Sockels ist erforderlich.

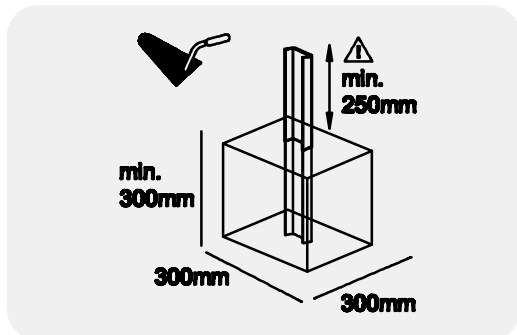

77033

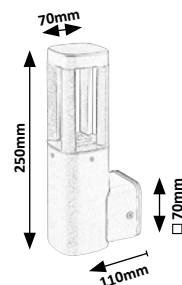

77032

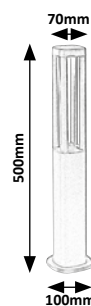

77031 (M) (P)

LED / 30W  
(2450lm, 3100lm;  
3000K) incl. • IP65  
anthracite grey/white



5 996595 770310

77032 (M) (P)

LED / 7W  
(250lm, 700lm;  
3000K) incl. • IP54  
anthracite grey/white



5 996595 770327

77033 (M) (P)

LED / 7W  
(250lm, 700lm;  
3000K) incl. • IP54  
anthracite grey/white



5 996595 770334





# CERNON



77054

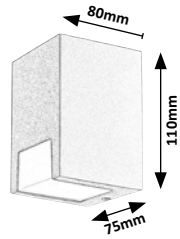

77055

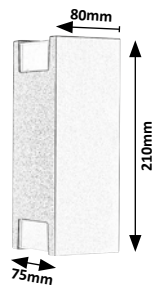

77056

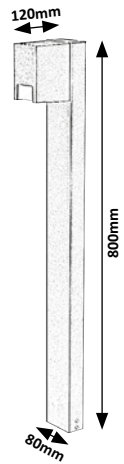

77054 (M) (P)

☒ GU10 / 1x max. 7W  
IP44 • 20048  
black/white



77055 (M) (P)

☒ GU10 / 2x max. 7W  
IP44 • 20049  
black/white



77056 (M) (P)

☒ GU10 / 1x max. 7W  
IP44 • 20048  
black/white



# HAREN

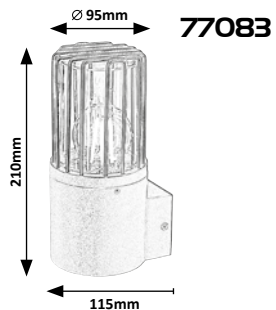

77084

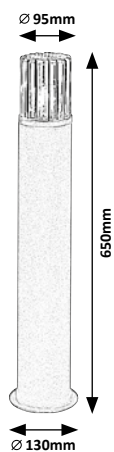

77083 (M P)

☒ E27 / 1x max. 60W  
IP54 • 20052  
black/transparent



5 996595 770839

77084 (M P)

☒ E27 / 1x max. 60W  
IP54 • 20052  
black/transparent



5 996595 770846





# LOANDA



**77080**

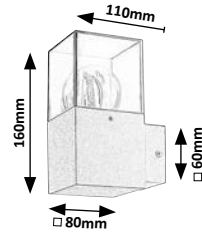

**77081**

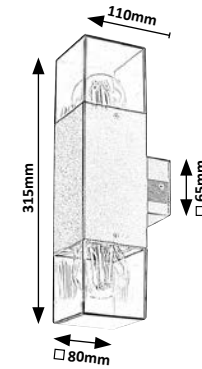

**77082**

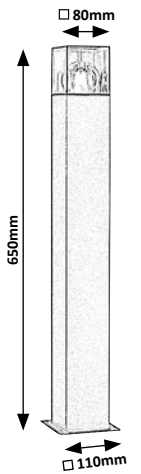

**77080** (M) (P)

⊗ E27 / 1x max. 60W  
IP54 • 20051  
black/tinted colour



5 996595 770808

**77081** (M) (P)

⊗ E27 / 2x max. 60W  
IP54 • 20051  
black/tinted colour



5 996595 770815

**77082** (M) (P)

⊗ E27 / 1x max. 60W  
IP54 • 20051  
black/tinted colour



5 996595 770822



# ZERNEST



**77085**



**77086**

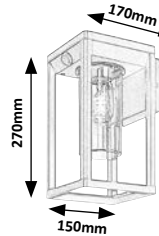

**77087**

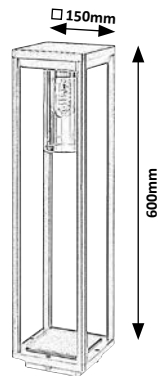

**77085** (M) (P)

☒ E27 / 1x max. 15W  
IP54 • 20056  
black/transparent



5 996595 770853

**77086** (M) (P)

☒ E27 / 1x max. 15W  
IP54 • 20056  
☑ 2-6m, 110°  
black/transparent



5 996595 770860

**77087** (M) (P)

☒ E27 / 1x max. 15W  
IP54 • 20056  
black/transparent



5 996595 770877



# LASSET

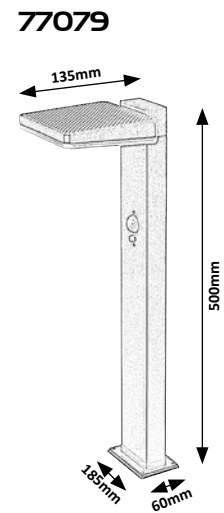
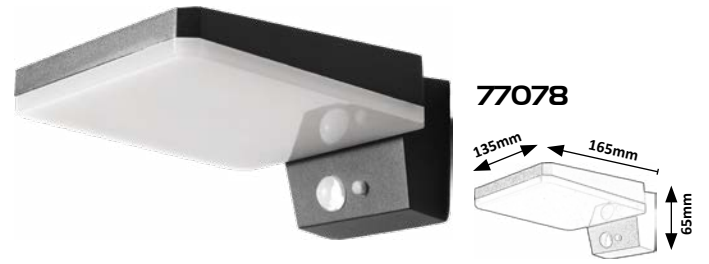

## 77078 (M) (P)

LED / 4,4W  
 (200lm, 600lm; 4000K) incl.  
 IP54 • 8m, 110° • 3,7V 2200mAh  
 black/white



5 996595 770785

## 77079 (M) (P)

LED / 4,4W  
 (200lm, 600lm; 4000K) incl.  
 IP54 • 8-12m, 110° • 3,7V 2200mAh  
 black/white



5 996595 770792

# GELEEN



**77044**

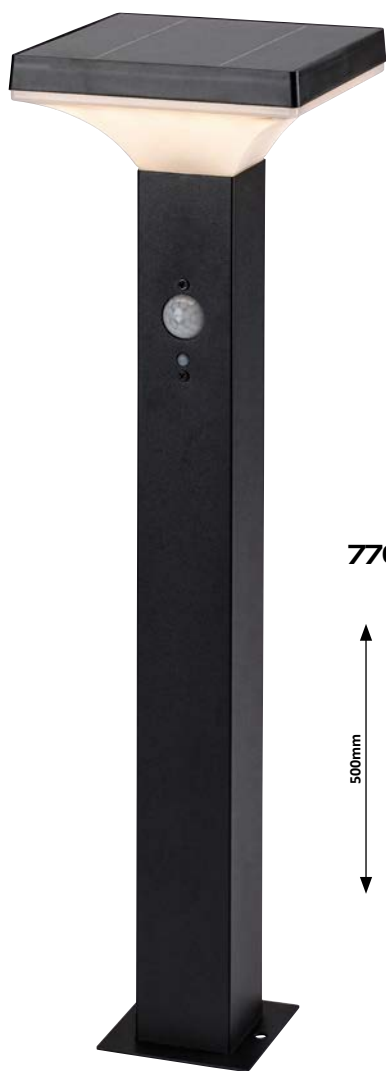
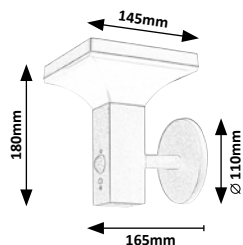

**77045**

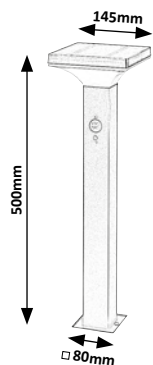

**77044**



DC 3,7V / LED / 4W  
 (400lm, 600lm; 3000K) incl.  
 IP44 • 6-8m, 110° • 3,7V 2200mAh  
 black/white



5 996595 770440

**77045**



DC 3,7V / LED / 4W  
 (400lm, 600lm; 3000K) incl.  
 IP44 • 6-8m, 110° • 3,7V 2200mAh  
 black/white



5 996595 770457







# ANGERS



**77037**



DC 3,7V / LED / 3W  
(300lm, 450lm; 4000K) incl.  
IP54 • 3-5m, 120° • 3,7V 2000mAh  
grey/transparent



5 996595 770372

**77038**



DC 3,7V / LED / 3W  
(300lm, 450lm; 4000K) incl.  
IP65 • 3,7V 2000mAh  
grey/transparent



5 996595 770389

**77039**



DC 3,7V / LED / 3W  
(300lm, 450lm; 4000K) incl.  
IP54 • 3,7V 2000mAh  
grey/transparent



5 996595 770396



# SENICA



77064

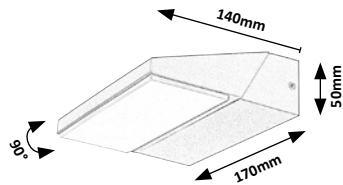

# TRENTO



77105

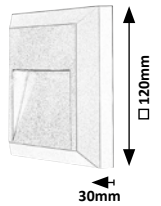

**77064** (M) (P)

LED / 13W  
 (E540lm, E1450lm;  
 4000K) incl. • IP65  
 black/white



5 996595 770648

**77105** (P)

LED / 4W  
 (E180lm, E400lm;  
 4000K) incl. • IP65  
 anthracite grey/transparent



5 996595 771058

77040, 77090

Mode A

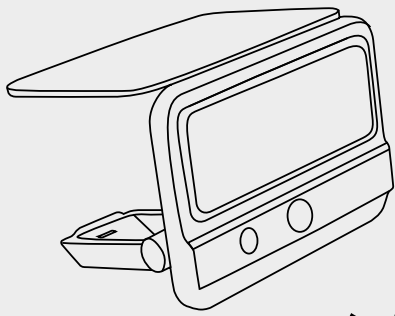

Mode B

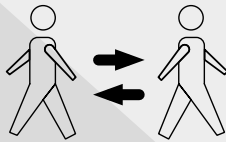
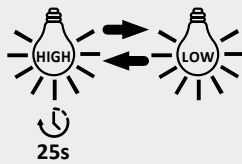

Mode C

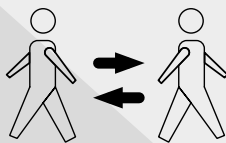
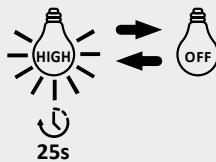

# FLAXTON



77040

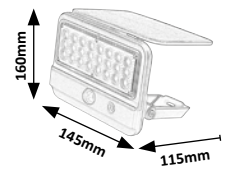

77090

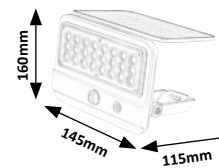

## 77040 P

☑ DC 3,7V / LED / 7W  
☑ 700lm, ☑ 800lm; 4000K incl.  
IP54 • ☑ 3-5m, 120° • 3,7V 3000mAh  
black/transparent



5 996595 770402

## 77090 P

☑ DC 3,7V / LED / 7W  
☑ 700lm, ☑ 800lm; 4000K incl.  
IP54 • ☑ 3-5m, 120° • 3,7V 3000mAh  
white/transparent



5 996595 770907

# LESZNO

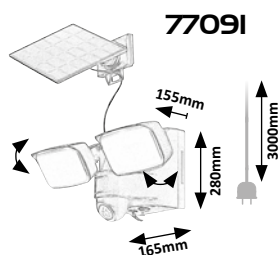

# NANTES



## 77091



☑ DC 3,7V / LED / 10W  
 (☑800lm, ☑1000lm; 4000K) incl.  
 IP54 • ☑ 3-5m, 120° • 3,7V 3600mAh  
 black/white



5 996595 770914

## 77088



☑ DC 3,7V / LED / 0,5W  
 (☑50lm, ☑250lm;  
 3000K) incl. • IP64 • 3,7V 2000mAh  
 black/transparent



5 996595 770884







## EMMEN



**77034**



## LUTTO



**77030**

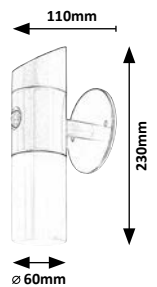

**77034** (P)

☑ DC 3,7V / LED / 0,5W  
 (☑50lm, ☑60lm;  
 3000K, 6000K) incl. • IP54 • 3,7V 1300mAh  
 black/transparent



5 996595 770341

**77030** (P)

☑ DC 3,7V / LED / 1W  
 (☑65lm, ☑90lm; 6500K) incl.  
 IP44 • ☑10m, 90° • 3,7V 1200mAh  
 black/white



5 996595 770303



## RUPIT

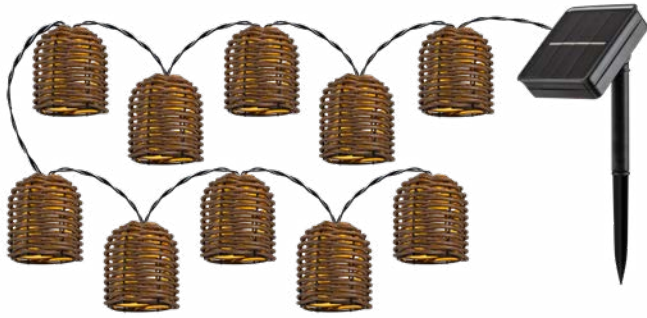

77047

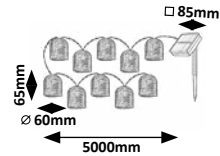

## TITU



77048

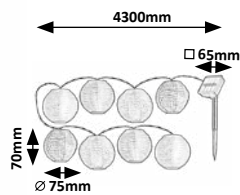

## SLUIS



77046

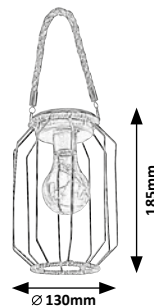

77047

(P)

☑ DC 1,2V / LED / 0,6W  
 (☑5lm, ☑10lm;  
 3000K) incl. • IP44 • 1,2V 600mAh  
 black/natural



5 996595 770471

77048

(P)

☑ DC 1,2V / LED / 0,48W  
 (☑4lm, ☑8lm;  
 3000K) incl. • IP44 • 1,2V 600mAh  
 black/multicolour



5 996595 770488

77046

(M)(P)

☑ DC 1,2V / LED / 0,2W  
 (☑3lm, ☑5lm;  
 3000K) incl. • IP44 • 1,2V 600mAh  
 black/transparent



5 996595 770464

# KONIN



77089

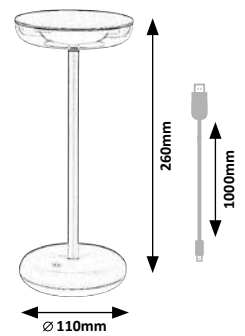

77089 **MP**

DC 5V / LED / 6W  
(60lm, 160lm;  
3000K) incl. • IP44 • 3,7V 1800mAh  
caramel/transparent



5 996595 770891

# ASSEN



77062

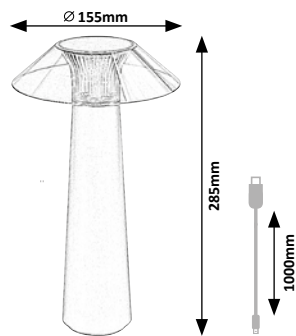

77062 **M P**

DC 5V / LED / 5W  
(40lm, 150lm;  
3000K) incl. • IP44 • 3,7V 2200mAh  
black/tinted colour



5 996595 770624





# KEY OF SYMBOLS • JELMAGYARÁZAT • ZEICHENERKLÄRUNG



	Symbols	Jelölések	Bezeichnungen	Symboles	Jména	Označenia	Oznaczenia	Позначення
	Lightsource recommendation	Fényforrás ajánló	Lichtquellenempfehlung	Recommandation de source lumineuse	Doporučený světelný zdroj	Odporičanie svetelného zdroja	Rekomendowane źródło światła	Рекомендація щодо джерела світла
	5 years guarantee	5 év garancia	5 Jahre Garantie	5 ans de garantie	záruka 5 let	Záruka 5 rokov	5-letnia gwarancja	гарантія 5 років
	built-in LED	beépített LED	LED inklusive	LED inclus	obsahuje LED	obsahuje LED diódy	Dioda LED w wyposażeniu	містить світлодіоди
	warm white light	meleg fehér fényű	warmweiß	blanc chaud	teplá bílá	teplá biela	ciepła biała	теплий білий
	natural white light	természetes fehér fényű	naturweiß	blanc naturel	přirozená bílá	přírodní biela	naturalna biała	натуральний білий
	cool white light	hideg fehér fényű	kaltweiß	blanc froid	studená bílá	studená biela	zimna biała	холодний білий
	Color temperature can be adjusted in 3 steps with a DIP switch	DIP kapcsolóval 3 lépésben szabályozható színhőmérséklet	Die Farbtemperatur kann mit einem DIP Schalter in 3 Stufen eingestellt werden	La température de couleur peut être ajustée en 3 étapes avec un interrupteur DIP	Teplotu barev lze nastavit pomocí DIP přepínače ve 3 krocích	Farebnú teplotu je možné nastaviť v 3 krokoch pomocou prepínača DIP	Temperaturę barwową można regulować w 3 krokach za pomocą przełącznika DIP	Колірну температуру можна регулювати в 3 кроки за допомогою DIP-перемикача
	dimmable with switch	szabályozható fényerő kapcsolóval	Lichtstärke Regler mit Schalter	Regleur d'intensité de la lumière avec commutateur	regulátor jasu se spínačem	regulátor jasu so spínačom	regulator napięcia światła z włącznikiem	регулятор потужності світла із перемикачем
	touch switch dimmer	érintőkapcsolóval szabályozható fényerő	Touchbutton-Lichtstärkereglер	réglage de la luminosité avec interrupteur tactile	nastavení jasu dotykovým spínačem	dotykový spínač na regulácia intenzity svetla	ściemniacz dotykowy	сенсорний диммер
	RGB colour change LED	RGB színváltós LED	Farbwechsel-LED	LED à changement de couleurs	LED diody střídající barvu	LED s meniacou sa farbou	Zmieniający kolor LED	Світлодіоди зі зміною кольору
	colour temperature variable with switch	kapcsolóval állítható színhőmérséklet	mit Schalter einstellbare Farbtemperatur	température de couleur réglable avec interrupteur	spínačem nastavitelná teplota chromatičnosti	možnosť nastavenia teploty farieb spínačom	temperatura barwy regulowana wyłącznikiem	кольорна температура, регульована перемикачем
	motion sensor	mozgásérzékelő	Bewegungssensor	détecteur mouvement	senzor pohybu	senzor pohybu	czujnik ruchu	датчик руху
	light reactive, only illuminates in the dark	fényérzékelő lámpa, csak sötétben világít	mit Helligkeitssensor, leuchtet nur im Dunkeln	l'appareil est muni d'un photodétecteur, il ne se manifestera que s'il est plongé dans l'obscurité	se světelným senzorem, svítí pouze ve tmě	so svetelným senzorem, svieti iba v tme	z czujnikiem oświetlenia, świeci tylko w ciemności	оснащений сутінковим світловим вмикачем, включається тільки при зниженні інтенсивності освітлення
	lamp operating with solar cells	napelemmel működő lámpa	Leuchte funktioniert über Solarzellen	luminaire fonctionnant avec une cellule photovoltaïque	svítidlo na solární baterii	plast odolný UV	lampa zasilana energią słoneczną	лампа на сонячній батареї
	IP protection	IP védettség	IP-Klasse	protection IP	IP krytí	IP ochrana	Stopień ochrony IP	Клас IP-захисту
	moveable heads	mozgatható fej	bewegliche Köpfe	têtes mobiles	pohyblivé hlavy	pohyblivé hlavy	ruchome głowy	рухомі голови
	night light function	éjszakai funkció	Nachtfunktion	fonction nuit	funkce nočního světla	funkcia nočného svetla	Funkcja światła nocnego	функція нічника
	memory function	memória funkció	Speicherfunktion	fonction mémoire	funkce paměť	funkcia pamäte	Funkcja pamięci	функція пам'яті
	micro-USB included	micro-USB tartozék	Micro-USB Zubehör	Avec Micro USB livré	Micro-USB v příslušenství	Príslušenstvo Micro-USB	Micro-USB w zestawie	Містить мікро-USB
	battery included	elemet tartalmaz	inklusive Batterie	pile incluse	součástí balení je baterie	súčasťou balenia je batéria	Bateria w zestawie	батарея додається
	environmentally friendly	környezetbarát	umweltschonend	écologique	je šetrný k životnímu prostředí	šetrný k životnému prostrediu	Przyjazny dla środowiska	безпечний для довкілля



# KEY OF SYMBOLS • JELMAGYARÁZAT • ZEICHENERKLÄRUNG



	Simboluri	Označavanje	Oznake	Oznake	Символи	Simboliai	Simboli	Sümbolid
	Recomandare sursa de lumina	preporuka za tip sijalice	Preporuka izvora svjetla	Odporúčanie svetelného zdroja	Препоръка за източник на светлина	Šviesos šaltinio rekomendacija	Ieteikums par gaismas avotu	Valgusallika soovitus
	5 ani garanție	5 godina garancije	5 godina jamstva	5 let garancije	5 години гаранция	5 metų garantija	5 gadu garantija	5-aastane garantii
	LED încorporat	ugrađeni LED	ugrađeni LED	vgrajen LED	вграден LED	Įmontuotas LED įrenginys	ieibūvēta LED	sisse-ehitatud LED
	alb cald	toplo bela	toplo bijelo	toplo bela	топло бяло	šiltai balta	silti balts	soe valge
	alb natural	prirodno bela	prirodno bijelo	naravno bela	естествено бяло	natūraliai balta	dabīgi balts	loomulik valge
	alb rece	hladno bela	hladno bijelo	hladno bela	студено бяло	šaltai balta	vēsi balts	külm valge
	Temperatura de culoare poate fi reglată în 3 trepte cu un comutator DIP	Температура боје се може подесити у 3 корака помоћу ДИП прекидача	Temperatura boje može se podesiti u 3 koraka pomoću DIP prekidača	Barvno temperaturo lahko nastavite v 3 korakih s DIP stikalom	Цветовата температура може да се регулира на 3 стъпки с DIP превключвател	Spalvos temperatūrą galima reguluoti 3 žingsniais DIP jungikliu	Krāsu temperatūru var regulēt 3 soļos ar DIP slēdzi	Värvitemperatuuri saab DIP-lülitiga reguleerida 3 astmes
	regulator intensitate lumina cu întrerupător	regulator svetlosti sa prekidačem	regulator jačie svjetla s prekidačem	zatemnilnik s stikalom	с регулатор за силата на светлина с превключвател	pritemdymo įtaisas su jungikliu	gaismainis ar slēdzi	hāmardi lūlitiga
	senzor tactil pentru reglarea luminozității	podešavanje jačine svetlosti sa prekidačem na dodir	podešavanje svjetline pomoću dodirne sklopke	Prilagodite svetlost z stikalom na dotik	регулатор на яркостта със сензорен превключвател	liečiamasis pritemdymo jutiklis	skārienjutīgs gaismaīna slēdzis	puutetundlik valgusregulaator
	LED RGB	LED sa promenljivim bojama	LED s promjenjivim bojama	LED diode s spremljivim barvama	LED с променлива светлина	Spalvų keičiantis LED	Maināmas krāsas LED	Värvi vahetav LED
	temperatura culorii controlată cu comutator	temperatura boja može da se podesi sa prekidačem	temperatura boja se može podesiti s prekidačem	barvna temperatura nastavljiva s stikalom	регулируема с ключ светлинна температура	jungikliu keičiama spalvos temperatūra	ar slēdzi maināma krāsu temperatūra	lūlitiga reguleeritav värvitemperatuur
	senzor de mișcare	senzor kretanja	senzor kretanja	senzor gibanja	със сензор за движение	judesio jutiklis	kustības sensors	liikumisandur
	cu sensor, luminează doar în întuneric	osjetljiv na svetlost, svetli samo u mraku	osjetljiv na svjetlost, svijetli samo u mraku	občutljivo na svetlobo, sveti le v temi	реагира на светлина, светва само, когато е тъмно	reaguoja į šviesą, užsidega tik tamsoje	reaģējošs uz gaismu, apgaismo tikai tumsā	valgusreaktiivne, valgustab vaid pimedas
	lampă cu acumulator solar	solarna lampa	solarna svjetiljka	sončna svetilka	лампа, работеща със слънчеви батерии	veikia su saulės energijos skydeliu	darbojas ar saules bateriju	sisselūlitamine pāikeseemendīga
	Protectia IP	IP zaštita	IP zaštita	IP zaščita	с IP защита	IP klasė	IP aizsardzība	IP kaitse
	capete mobile	покретне главе	pokretni glave	premične glave	подвижни глави	judamosios galvos	pārvietojamas galvas	liikuvad pead
	Funcție lumina de noapte	funkcija nočno svetlo	funkcija noćnog svjetla	nočna funkcija	функция нощна светлина	naktinio apšvietimo funkcija	nakts apgaismojuma funkcija	ööine funktsioon
	Funcție de memorie	funkcija pamćenja	funkcija memorije	pomnilna funkcija	функция памет	atminties funkcija	atmiņas funkcija	mälu funktsioon
	Accesorii Micro-USB	Mikro-USB dodatna oprema	Mikro USB pribor	Mikro USB-pripomoček	С принадлежност Micro-USB	Pridedama „Micro-USB“	Micro-USB iekļauts komplektā	Mikro-USB komplektis
	bateria este inclusă	baterija u opremi	baterija je uključena	baterije so uključene	предоставена батерия	su baterija	baterija ietilpst komplektā	patarei kuulub komplekti
	ecologic	ekološki prihvatljiv	ekološki prihvatljiv	okolju prijazno	щадящ околната среда	draugiškas aplinkai	videi draudzīgs	keskkonnasõbralik

# COLOURS • SZÍNEK • FARBEN

 GBR	 HUN	 GER	 FRA	 CZE	 SVK	 POL	 UKR
anthracite grey	antracit	Anthrazit	anthracite	antracitová	antracit	antracyt	антрацитовий
transparent	átlátszó	transparent	transparent	průhledná	priehľadná	przeźroczysty	прозорий
brown	barna	Braun	brun	Hnědá	hnedá	Brązowy	коричневий
white	fehér	Weiss	blanc	bílá	biela	biały	білий
black	fekete	Schwarz	noir	černá	čierna	czarny	чорний
tinted colour	füst színű	Rauchfarbig	fumée	dýmová barva	dymová	przydymiony	димчастий
caramel	karamell	karamellfarbe	couleur caramel	karamelová barva	karamelová farba	kolor karmelowy	карамельний колір
natural	natúr	Naturfarbig	nature	přírodní	přírodná	naturalny	натуральний
grey	szürke	Grau	gris	šedá	šedá	popielaty	сірий
multicolour	többszínű	Multicolor	multicolore	vícebarevná	viacfarebná	wielokolorowy	багатокольоровий

 ROM	 SRB	 CRO	 SLO	 BUL	 LTU	 LVA	 EST
antracit	antracit	antracit	antracitna	антрацитен	antracito pilka	antracita pelēks	hall antratsiit
transparent	providan	proziran	prozorno	прозрачен	skaidri	caurspīdīgs	läbipaistev
maro	smeđa	braun	rjavo	кафяв	ruda	brūns	pruun
alb	belo	bijelo	belo	бял	balta	balts	valge
negru	crno	crno	črno	черен	juoda	melns	must
fumuriu	boje dima	indigo plava	barva dima	прозиращо кафяво	su atspalviu	tonēta krāsa	toonitud värv
culoare caramel	карамель боја	karamela boja	barva karamela	кара멜ен цвят	karamellkrāsa	karamelinē spalva	karamellivärv
natur	natur	natur	naravno	натурален	natūrali	dabiski	loomulik
gri	sivo	sivo	sivo	сив	pilka	pelēks	hall
multicolor	višebojno	višebojno	večbarvno	многоцветен	jvairiaspalvė	daudzkrāsains	mitmevärviline

## CONTENTS • TARTALOMJEGYZÉK • INHALTSVERZEICHNIS

Art. number	Name	Page	Art. number	Name	Page	Art. number	Name	Page	Art. number	Name	Page	Art. number	Name	Page
Cikkszám	Név	Oldal	Cikkszám	Név	Oldal	Cikkszám	Név	Oldal	Cikkszám	Név	Oldal	Cikkszám	Név	Oldal
Art. nummer	Name	Seite	Art. nummer	Name	Seite	Art. nummer	Name	Seite	Art. nummer	Name	Seite	Art. nummer	Name	Seite
77069	Domme	4	77100	Lublin	9	77101	Telde	18	77082	Loanda	24	77090	Flaxton	30
77070	Domme	4	77065	Temse	10	77102	Telde	18	77085	Zernest	25	77091	Leszno	31
77095	Andelle	5	77066	Temse	10	77103	Medna	19	77086	Zernest	25	77088	Nantes	31
77096	Andelle	5	77049	Tilburg	12	77104	Medna	19	77087	Zernest	25	77034	Emmen	32
77094	Rennes	5	77050	Tilburg	12	77031	Kalisz	20	77078	Lasset	26	77030	Lutto	32
77097	Gimone	6	77051	Ognon	12	77032	Kalisz	20	77079	Lasset	26	77047	Rupit	33
77098	Gimone	6	77041	Hulst	14	77033	Kalisz	20	77044	Geleen	27	77048	Titu	33
77092	Zaragoza	7	77061	Gendt	14	77054	Cernon	22	77045	Geleen	27	77046	Sluis	33
77093	Zaragoza	7	77035	Indre	15	77055	Cernon	22	77037	Angers	28	77089	Konin	34
77073	Mataro	8	77036	Indre	15	77056	Cernon	22	77038	Angers	28	77062	Assen	35
77074	Mataro	8	77057	Odiel	16	77083	Haren	23	77039	Angers	28			
77075	Mataro	8	77058	Odiel	16	77084	Haren	23	77064	Senica	29			
77076	Mataro	8	77059	Odiel	17	77080	Loanda	24	77105	Trento	29			
77099	Lublin	9	77060	Odiel	17	77081	Loanda	24	77040	Flaxton	30			

## IMPRINT • IMPRESSZUM • IMPRESSUM

### English

Colour and pattern discrepancy are possible. We are entitled to change the pattern.  
We don't bear the responsibility of the printing failure.

### Magyar

Szín és minta eltérés lehetséges. A minta változtatás jogát fenntartjuk!  
Az esetleges nyomdai hibákért elnézésüket kérjük és azokért felelősséget nem vállalunk.

### Deutsch

Farbe und Musterunterschied ist möglich. Wir halten das Recht von Musteränderung aufrecht.  
Vor die eventuellen Druckfehler bitten wir um Entschuldigung und vor die Fehler können wir die Verantwortung nicht übernehmen.

Grafikai munkák: Visionext Reklámstúdió

# CONTACT • ELÉRHETŐSÉGEINK • KONTAKT

## CENTRE/KÖZPONT/ZENTRALE



### Magyarország/Hungary

RÁBALUX HEAD OFFICE  
RÁBALUX VILÁGÍTÁSTECHNIKA ZRT.  
VILÁGÍTÁSTECHNIKA GYÁRTÁS ÉS FORGALMAZÁS/  
LIGHTING PRODUCTION AND DISTRIBUTION

9027 Győr, Körtefa u. 5.  
Tel.: +36 96 526 716  
E-mail: info@rabalux.com  
www.rabalux.com

## AFFILIATES/LEÁNYVÁLLALATOK/ZWEIGSTELLEN



### Bulgaria

РАБАЛУКС ЕООД / RABALUX EOOD  
ул. "Андрей Николов" №15,  
1111 София,  
България  
Тел./Факс: +359 2 936 00 97  
E-mail: infobg@rabalux.com  
www.rabalux.bg



### Croatia, Bosnia Herzegovina, Montenegro

RABALUX RASVJETA d.o.o.  
Ulica grada Gospića 1a  
10000 Zagreb  
Tel.: +385 1 652 80 66  
E-mail: infocro@rabalux.com  
www.rabalux.hr



### Czech Republic

RABALUX CZ Svítidla s.r.o.  
Kaštanová 141/a, 617 00 Brno,  
Česká Republika  
Tel.: +420 739 665 322  
E-mail: infocz@rabalux.com  
www.rabalux.cz



### Hungary

Rábalux Magyarország Kft.  
Magyarország  
9027 Győr,  
Körtefa u. 5.  
Tel.: +36 96 526 716  
E-mail: infohu@rabalux.com  
www.rabalux.hu



### Lithuania, Latvia, Estonia

UAB „Rabalux Baltic“  
Bičiulių g. 29,  
LT-14182 Bukiškis,  
Vilniaus r. Lietuva  
Tel.: +370 6161 3066  
E-mail: infobaltic@rabalux.com  
www.rabalux.lt



### Poland

Rabalux Sp. z o.o.  
ul. Sołtysia 119, 40-750 Katowice,  
Polska  
Tel.: +48 32 254 61 34  
E-mail: infopl@rabalux.com  
zamowienia@rabalux.com  
www.rabalux.pl



### Romania

SC RABALUX SRL  
Cluj-Napoca, str. Fabricii,  
nr. 93-103, jud. CLUJ  
Romania  
cod postal: 400632  
Tel.: +40 264 456 040  
E-mail: inforo@rabalux.com  
www.rabalux.ro



### Serbia, Northern Macedonia

Rabalux SRB d.o.o.  
Autoput br.20  
11080 Beograd –  
Zemun, Srbija  
Mob: + 381 60 444 3977;  
Tel.: +381(0)11 2013 986  
E-mail: infosrb@rabalux.com  
www.rabalux.rs



### Slovakia

RABALUX SK. Svetidlá, s.r.o.  
Alžbetínske nám. 328,  
929 01 Dunajská Streda,  
Slovenská Republika  
Tel.: +421 31 551 54 04  
E-mail: infosk@rabalux.com  
www.rabalux.sk



### Ukraine

ТОВ Рабалукс,  
вул. Рилеева 4, м. Ужгород,  
Україна, 88017  
тел.: +38 0312 64 04 00,  
моб.тел.: +38 067 310 05 20  
E-mail: infoua@rabalux.com  
www.rabalux.ua

## OFFICIAL RESELLERS/MEGBÍZOTT VISZONTELADÓK/BEAUFTRAGTE WIEDERVERKÄUFER



### Germany

Sinnocon GmbH  
01156 Dresden,  
Breitscheidstr. 45  
Tel.: +49 351 65335641  
E-mail: rabalux@sinnocon.de  
www.sinnocon.de



### Slovenia

Lagea d.o.o.  
Brezina 19c  
8250 Brežice  
Republika Slovenija  
Tel.: +386 70 292 70 20  
E-mail: elmatis@lagea.si



### Greece

ANASTASIADI SA  
1km Katerini-Ganohora Road,  
Katerini, 60100  
Tel.: +30 2351039757  
E-mail: eshop@anastasiadi.gr  
www.anastasiadi.gr



### Greece

S.MELISSOURGOS CO OE  
8 Kourtiou St,  
11146 Galatsi,  
Tel.: +0030 2102136040  
E-mail: info@melissourgos.com.gr  
melissourgos.com.gr



### Portugal

STORM LIGHT,LDA  
Rua António Pereira Vidal Xavier nº9,  
3750-802 Valongo do Vouga,  
Tel.: 234 661 068  
E-mail: geral@storm-light.pt  
www.storm-light.pt



### Spain

Buyled Led Lighting S.L  
03007, Alicante,  
ES, C/Gillen de Castro 1  
Tel.: +34 654 870 866  
E-mail: info@buyled.es  
www.buyled.es



### Italy

Fra.Co.Distribuzione Srl  
Sp1 km24,  
90047 Partinico (PA)  
Tel.: 0039 0915071547  
E-mail: info@fracodistribuzione.it  
www.fracodistribuzione.it



### Finland

Focus Interiors Oy  
Kuusipolku 35,  
37150 Nokia  
Tel.: +358 (0)10 3270 520  
E-mail: info@focusinteriors.fi  
www.focusinteriors.fi



### Qatar

GO GREEN INTERNATIONAL  
TRADING W.L.L  
New Salata, C Ring Road,  
Sharq Capital Building-311 P.O Box 37372,  
Doha, Qatar  
Tel.: (+974) 4409 5443, (+974) 5552 9088  
E-mail: sales@ggilighting.com  
www.ggilighting.com



### United Kingdom

Lighting Direct  
24-26 Vincent Ave,  
Crownhill, Milton Keynes  
Buckinghamshire, MK8 0AB  
E-mail: customerservice@lighting-direct.co.uk  
www.lighting-direct.co.uk





[www.rabalux.com](http://www.rabalux.com)